

Data Sheet



Article number: 204040M12125A3SK

Description: E+G levelling foot
GN 40-40-M12-125-A3-SK

Note: SK With nut, External hexagon at the bottom

Measures

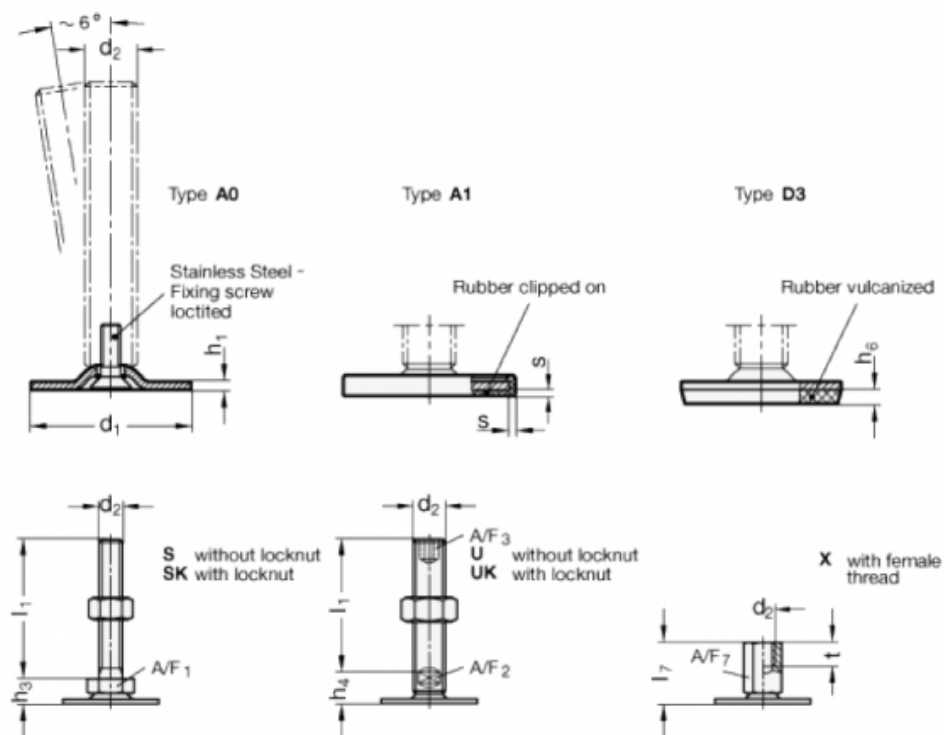

A/F1	= 17
d1	= 40
d2	= M12
h1	= 2
h3	= 11
h6	= 3.5
l1	= 125
s	=